

Alfa Up Assembly Instructions

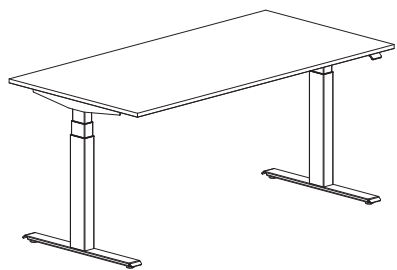

Alfa Up Assembly Instructions



Single

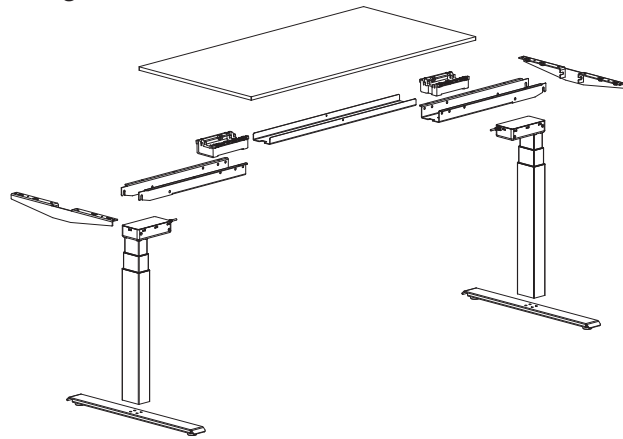

							1x 510291699		
1	2	3	4	5	6	7	8	9	10
M8x20 4x	M8x20 8x	M6x16 8x	4x16 2x	4.5x24 18x	12x	M8 4x	DIN 7500CT M6x16 PH TORX 1x	4.8x16 28x	DIN7985 M6x16 8x

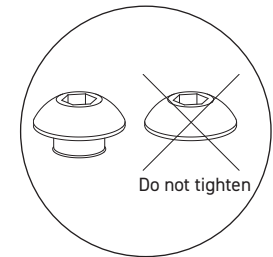
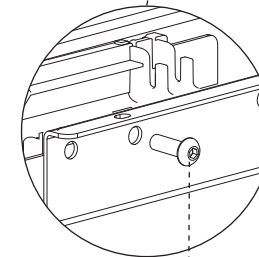
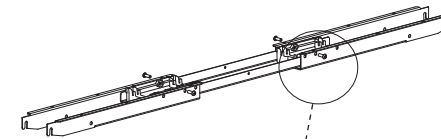
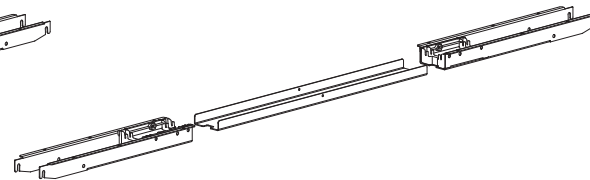
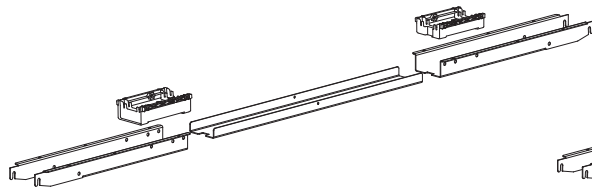
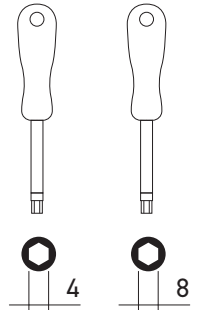









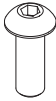

Alfa Up Assembly Instructions

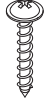

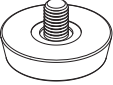
Single

1x 510291699

1	2	3	4	5	6	7	8	9	10
									
M8x20 4x	M8x20 8x	M6x16 8x	4x16 2x	4.5x24 18x	12x	M8 4x	DIN 7500CT M6x16 PH TORX 1x	4.8x16 28x	DIN7985 M6x16 8x

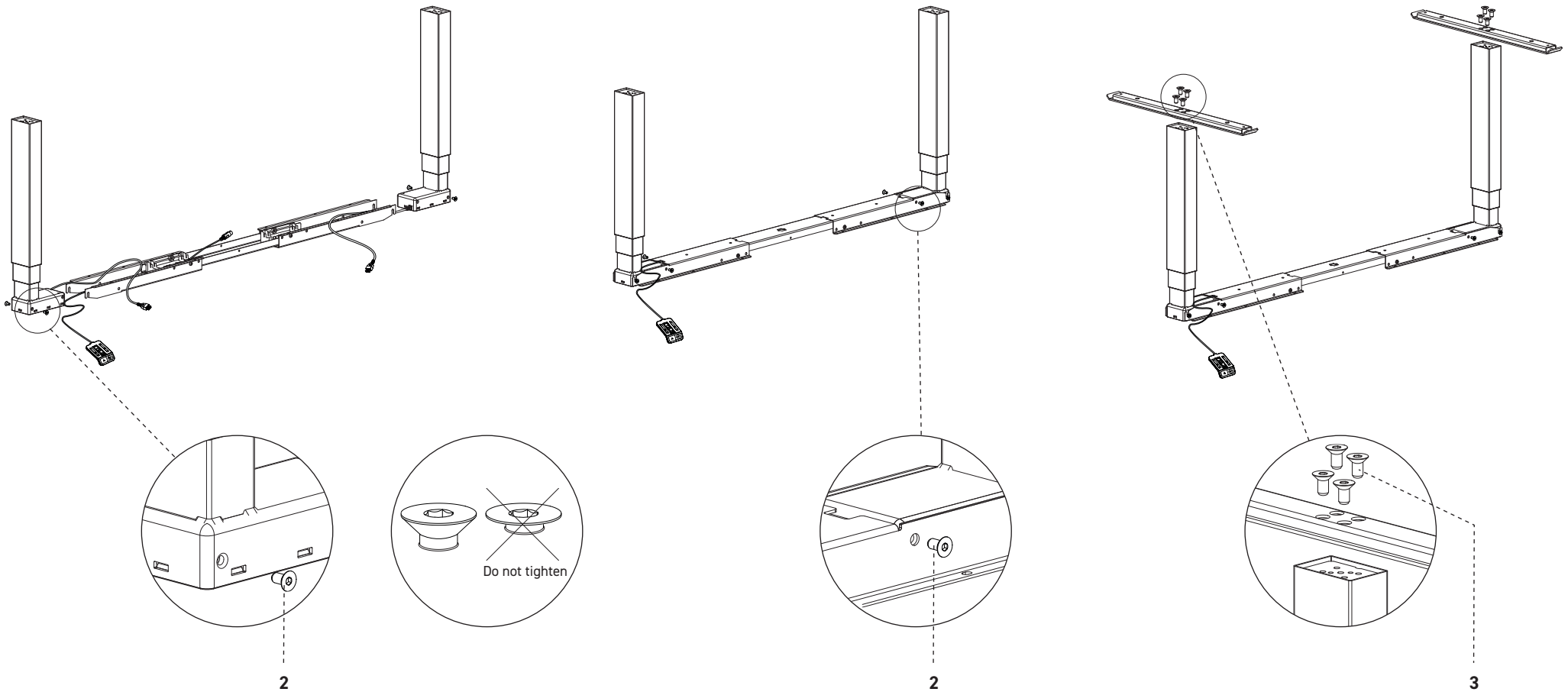
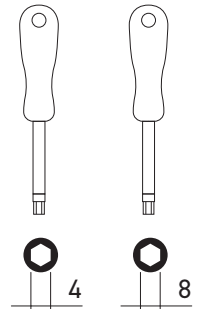

Alfa Up Assembly Instructions



Single

1	2	3	4	5	6	7	1x 510291699		
M8x20 4x	M8x20 8x	M6x16 8x	4x16 2x	4.5x24 18x	12x	M8 4x	DIN 7500T M6x16 PH TORX 1x	4.8x16 28x	DIN7985 M6x16 8x

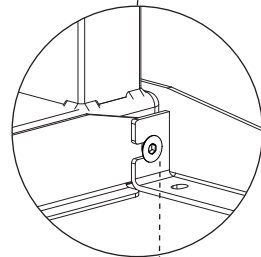
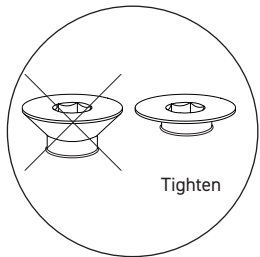
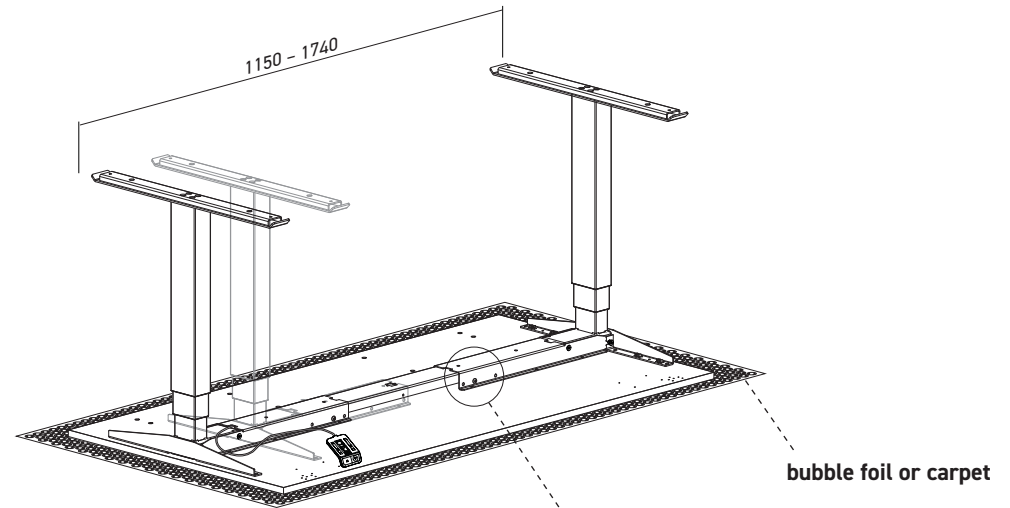
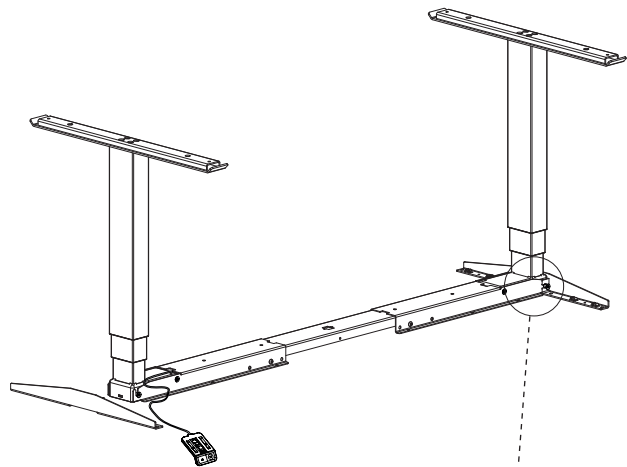
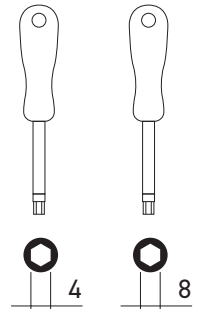

2

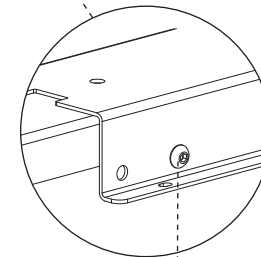
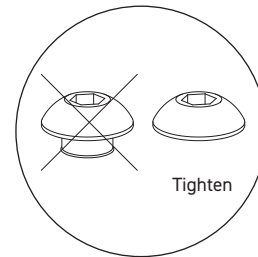











1

Alfa Up Assembly Instructions

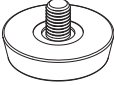

Single

1x 510291699

1	2	3	4	5	6	7	8	9	10
									
M8x20 4x	M8x20 8x	M6x16 8x	4x16 2x	4.5x24 18x	12x	M8 4x	DIN 7500CT M6x16 PH TORX 1x	4.8x16 28x	DIN7985 M6x16 8x

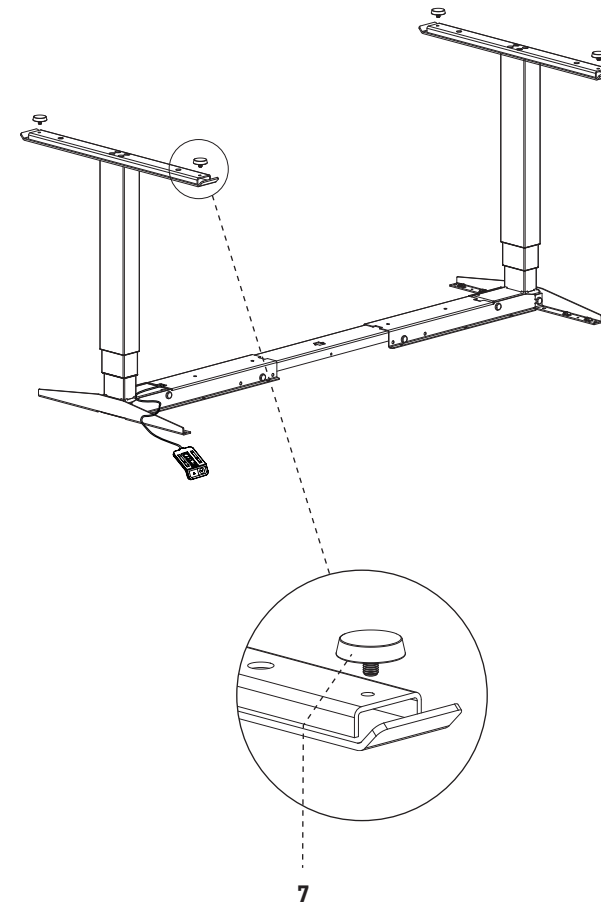
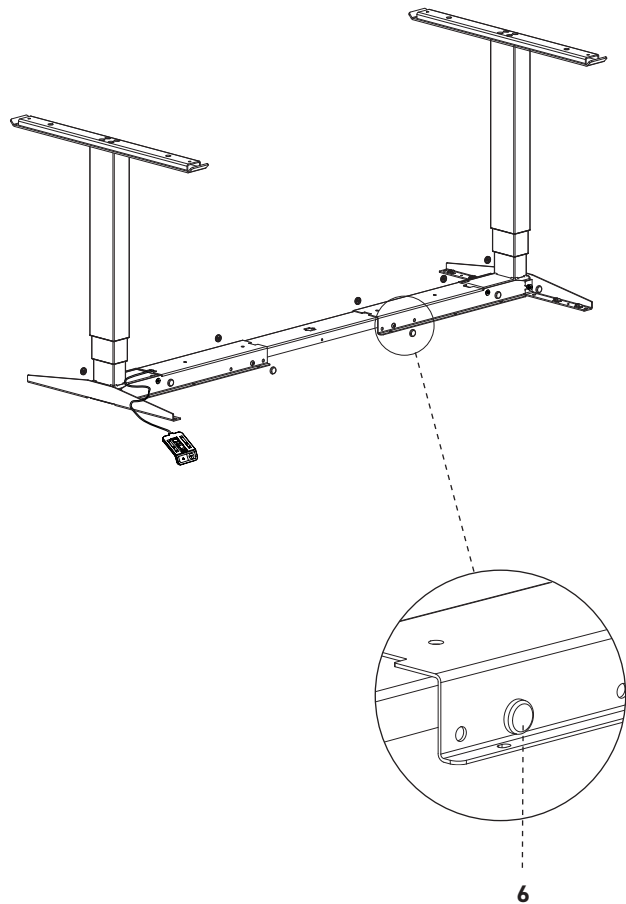
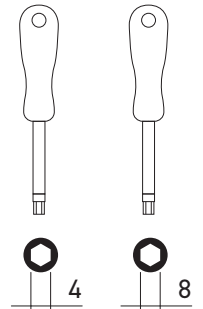

Alfa Up Assembly Instructions



Single

1x 510291699

1	2	3	4	5	6	7	8	9	10
M8x20 4x	M8x20 8x	M6x16 8x	4x16 2x	4.5x24 18x	12x	M8 4x	DIN 7500CT M6x16 PH TORX 1x	4.8x16 28x	DIN7985 M6x16 8x

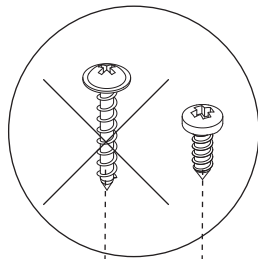
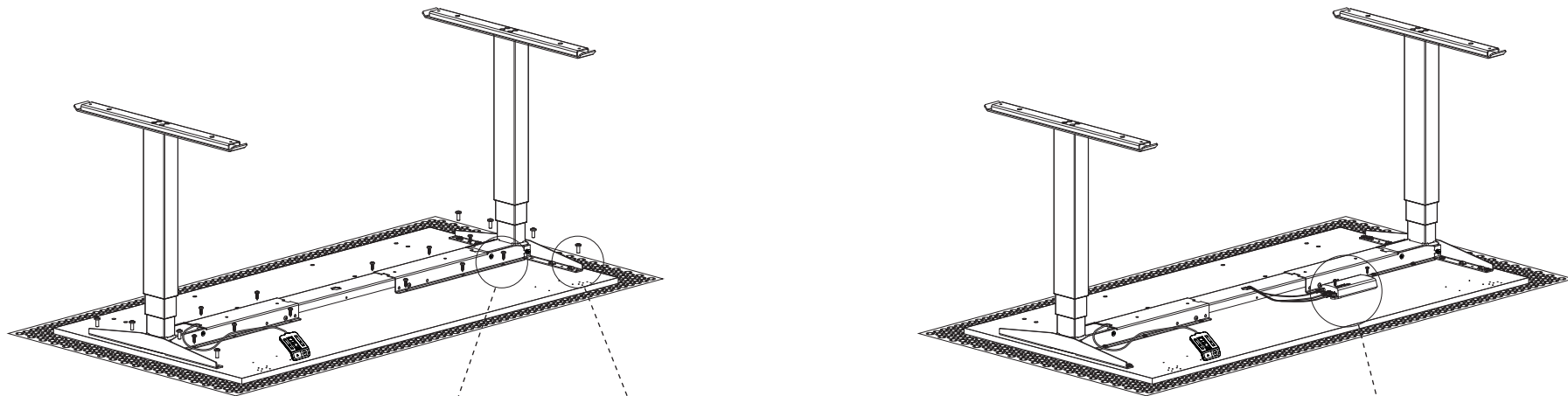
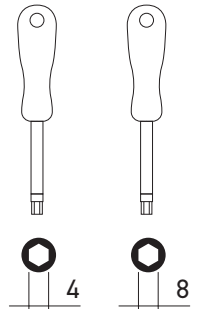

5

9

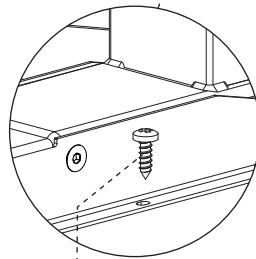

9

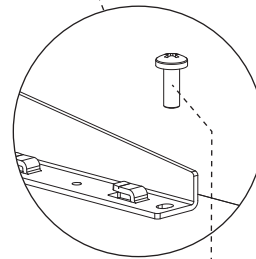

10

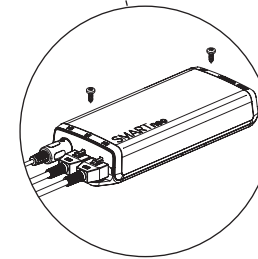
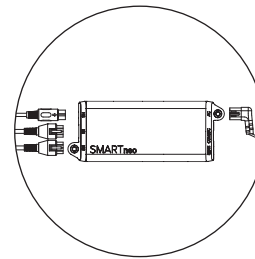

Alfa Up Assembly Instructions

Single

1	2	3	4	5	6	7	1x 510291699		
M8x20 4x	M8x20 8x	M6x16 8x	4x16 2x	4.5x24 18x	12x	M8 4x	DIN 7500CT M6x16 PH TORX 1x	4.8x16 28x	DIN7985 M6x16 8x

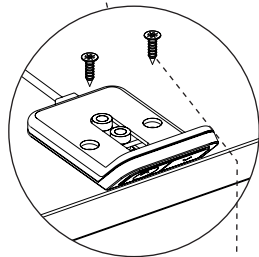
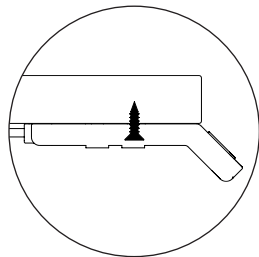
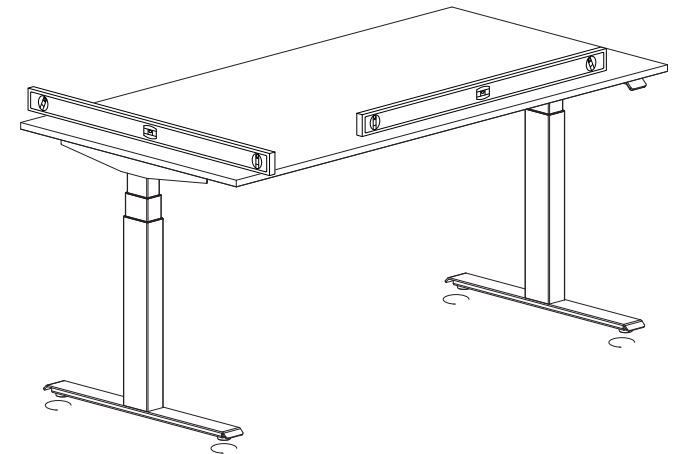
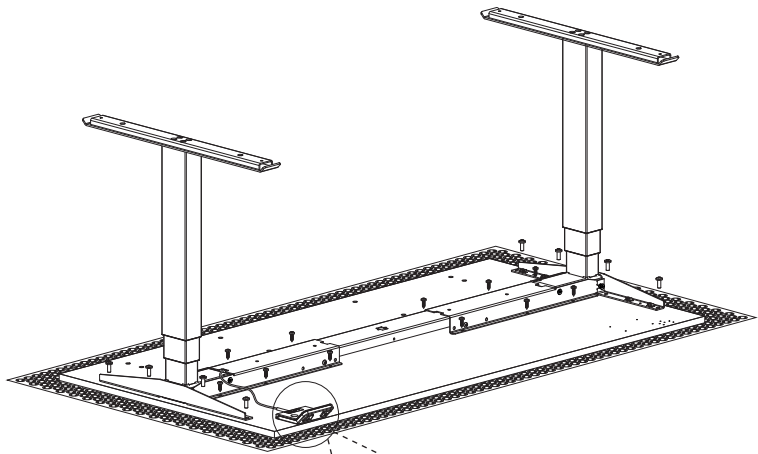
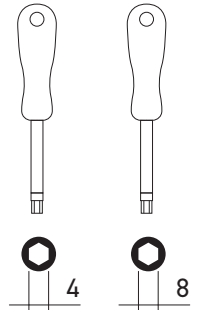

or

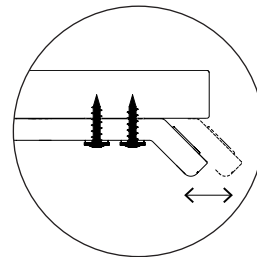
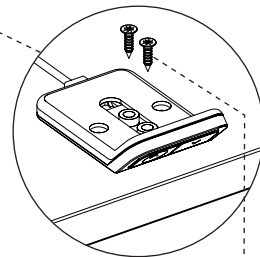

4

5

Alfa Up Assembly Instructions

Single

Reset procedure

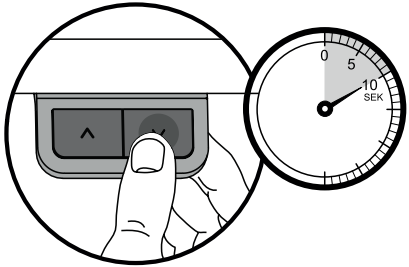

Lower the frame to its lowest position by pressing the down arrow on the hand control. Release the button. Press the button again and keep it pressed for 10 seconds, the reset is now carried out and the frame is ready to use.

